

S U M M E R 2 0 1 4



Canada Lakes Protective Association

Rules of the Waves

We all can enjoy our lakes if we all work together

A reminder from the Town of Caroga Navigation Committee

IT IS COURTEOUS TO:

- Operate your craft in a manner which does not endanger others
- Operate your craft in a manner which avoids excess noise

IT IS GOOD FOR THE ENVIRONMENT:

- To keep your trash and litter out of the lake and it is the law
- To operate your craft away from weed beds
- To keep soap out of the lake



BOATING REGULATIONS

- Always ski with a spotter in the boat who is at least 10 years old
- Ski during daylight hours
- Maintain speed at or below 5 mph within 100' of shore, docks, skiers and swimmers, unless you are dropping off or picking up a skier
- Utilize navigation lights after sunset
- Provide an approved life jacket for everyone aboard the craft
- Vests must be worn by all children under 12
- A throwable life preserving device must be present in the boat
- Do not operate a craft while impaired by any drug or alcoholic beverage
- Engines on all crafts must be reasonably muffled
- Operators are responsible for any damage caused by their wakes
- Minimum age to operate a power boat is 10
- Age 10 to 18 must complete a safe boating course to operate a power boat without adult supervision
- The minimum age for operating a PWC is 14
- "Everyone" must complete a safe boating course to operate a Personal Water Craft

**For Emergencies Only
Dial 911**

**Non Emergencies:
Call the Fulton County
Sheriff's Department at
518-736-2100**

**IT IS EVERYONE'S
RESPONSIBILITY TO
USE COMMON SENSE
AND ACT SAFELY**



2014 Officers

President: Lois Miller 835 - 6703
President Elect: David Graves 835 - 2396
Secretary: Deborah Hoffman 835 - 6066
Treasurer: John Snyder 835 - 2561

Directors and Terms

Terms Ending 2014

Merryn Byrnes 835 - 8026
Linda Clark 835 - 6670
Henry Eifert (315) 429 - 8810
Bill Fielding 835 - 6069
Rick Fink 835 - 6070
Warren Roosevelt 835 - 6235
John Snyder 835 - 2561

Terms Ending 2015

Dick Arthur 399 - 4473
Erin Beaudet 604 - 4084
Dave Graves 835 - 2369
Deborah Hoffman 835 - 6066
Mark Moritz 835 - 3003
Chris Rohrs 835 - 8730
John Saunders 604 - 4117

Terms Ending 2016

John Broderick 835 - 6150
Edward Fake 835 - 2447
Mary Jablonski 835 - 6033
Richard Maider 835 - 8598
Lois Miller 835 - 6703
Douglas Smith 835 - 6692
Anthony Sturchio 835 - 6896

The Echo Needs Writers!

**Stories!
Information!
Echoes!**
All Ages Are Welcome!

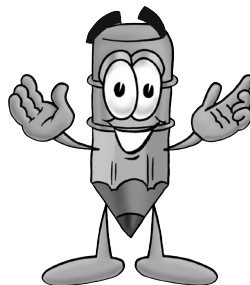

**If you think you can't
write don't worry we
have great editors**

**Remember, we don't have
an Echo without input from
lake residents.**

Start thinking now about how
you can contribute to the

**2015 Echo
60th Aniversary Issue**

For more information contact:
echo@carogalake.com

2014 Committees

Lake Management:

Mary Jablonski - *Vice President*

Environment and Ecology

Dave Graves - *Chair*

Janice Corr

Alan Farber

Jim Hays

Sherry LaBelle

Rosemary Lee

Carol Lernihan

Nancy Schreher,

Sandy Sheedy

Doug Smith

John Snyder

Sandy Sturchio

Fire Safety

Bill Fielding - *Chair*

Betsy Cannon

Sue Fink

Frank Lichtneger

Mike Manning

Alan Peck

Dixon Peters

Fishing

John Plantz - *Chair*

Judy Aldinger

Dan Dopp

Dave Falvo

Al Fenoy

Joe Jablonski

Ken Luttmann

Tom Lyons

Mike Manning

Tim Mitchell

Doug Smith

John Snyder

Dan Yuenger

Lake Safety

Tony Sturchio - *Chair*

Sheri LaBelle

Doug Smith

Property Assessment

Linda Clark - *Chair*

Stewardship Committees

Campsites

Betsy Cannon - *Chair*

Lois Miller

Courtney Young

Highway

John Broderick - *Co-Chair*

Chris Moritz - *Co-Chair*

Roy Smith

Fire Tower

Tim Mitchell - *Chair*

John Broderick

Betsy Cannon

Dave Cannon

Bill Fielding

Karen Gniewek

Diane Guistinaini

Marcus Harizan

Mike Manning

Ann Michalek

Doug Smith



2014 Committees

Island

Mary Peck - *Chair*
Brian Franz
Harrison Franz
John Peck
Joshua Peck

Doug Smith
John Snyder
Pat Snyder
Sandy Sturchio
Sue Tantalo
Courtney Young
Nancy Young

Invasive Species

Jim Hays - *Chair*
Dick Arthur
Erin Beaudet
John Broderick
Michael Durkee
Allen Farber
Al Fenoy
Dave Graves
Marcus Harazin
Dave Hoffman
Jeannie Im
Dick Loomis
Dick Maider
Jack McCarthy
Liz McDonald
Jim Memmott
Ann Michalek
Lois Miller
Sue Mitchell
Tim Mitchell
Karen Muller
Mary Peck
Nancy Pickels
Robert Pickels
Dixon Peters
Cathy Rechlin
Chris Rohrs
John Saunders
Sandy Sheedy
Steve Sheedy

Adopt A Shoreline

Dave Hoffman - *Chair*
David Falvo
Bret Fielding
David Hoffman 3
Mike Hoffman
Joe Jablonski
Dan Kane
Ken LaBelle
Sherry LaBelle
Sam Lee
Jay Manning
Eric Manning
Elizabeth McDonald
Jim Memmott
Karen Memmott
Catherine Rechlin
Tom Rechlin
Warren Roosevelt
Phyllis Sanford
Dan Tantalo
Sue Tantalo
Bonnie Van Wagenen
Neil Van Wagenen

Water Level

Bill Fielding - *Chair*
Dick Arthur
Henry Eifert
Bret Fielding

2014 Committees

Lauren Lozier
Pete Lozier
Mike Manning
Tim Mitchell
Sandy Sheedy
Doug Smith

Water Purity

Merryn Byrnes - *Chair*
John Byrnes
Archer Newell
Maggie Newell

Lake Organization

Dick Arthur - *Vice President*

Adirondack

Jim Hayes- *Chair*
Mike Cannon
Mike Durkee
Dave Graves
Tim Mitchell
Alan Peck
Doug Smith
John Snyder

By-Laws

Dick Maider - *Chair*
Linda Clark

Directory

Dick Arthur - *Chair*
Merryn Byrnes
Lane Franz
Carole Fisher
Cheryl Gifford
Ruth Kerr
Dorothea Loomis

Cassandra Lyon
Barbara Kane Russell
Sandy Sturchio
Sue Tantalo
Edwin Woods

Fire Department

Alan Peck - *Coordinator*

Lake Publication: The Echo

Christine Moritz - *Co-Editor*
Mark Moritz - *Co-Editor/Designer*
Merryn Byrnes
Parker Davis
Sherry LaBelle
Nicolle Moritz

Legal

Dick Maider - *Chair*
Linda Clark
Diana Leaf

Membership

Merryn Byrnes - *Chair*
Dorothy Eifert
Dorothy Fielding
Dorothea Loomis
Lois Miller
Alan Peck
Mary Peck



2014 Committees

Nominating

John Saunders - *Chair*
Linda Clark
Dorothy Eifert
Tim Eldred
Warren Robbins
Chris Rohrs

Welcoming

Lois Miller - *Chair*
Lane Franz

Winter Emergency

Tony Sturchio - *Chair*
Henry Eifert
Dorothea Loomis
Lauren Lozier
Pete Lozier
Alan Peck
John Saunders
Doug Smith

Website

Erin Beaudet
Merryn Byrnes
Allen Farber
Mary Peck
Chris Rohrs
Kathy Rohrs

Lake Activities

Erin Beaudet - *Vice President*

Boat Parade

Kristen Franz - *Co- Chair*
Bryan Franz - *Co- Chair*
Carol Fisher
Katie Kiesewetter

Flare Lighting

Rennix Offutt - *Chair*
Jackie Fake
Grant Putnam
Kieran Ryan

Fireworks

Mike Manning - *Chair*
Bill Fielding
Brett Fielding

Sailing

Courtney Young - *Commodore*
Nancy Young - *Vice Commodore*
Lisa Lawrence

Social Functions:

Ice Cream Extravaganza
Erin Alexander - *Co-Chair*
Mary Peck - *Co-Chair*
Lois Miller
Dixon Peters



Luncheon

Maureen Offutt - *Chair*
Dorothy Eifert
Deb Hoffman
Mary Jablonski
Judy Moritz
Liz Putnam
Josie Roosevelt
Audrey Smith
Sue Tantalo
Bonnie Van Wagenen

2014 Committees

Picnic

Josie Roosevelt - *Co-Chair*
Warren Roosevelt - *Co-Chair*
Jill Marie Dippel
Dorothy Eifert
Henry Eifert
Mary Kate Farber
Rick Fink
Brian Franz
Kristin Franz
Dave Hoffman
Deb Hoffman
Elayne Ireland
Ken LaBelle
Sherry LaBelle
Liz Putnam
Diana Leaf
Chris Rohrs
Bob Ryan
Dan Tantalo
Sue Tantalo
Charles Thompson
Shawna Thompson

Youth Activities

Kathy Luttmann *Co-Chair*
Amanda Ward *Co-Chair*
Mary Shawn Egan
Mary Peck
Jen Spinnoble
Shauna Thompson

CLPA VOLUNTEERS NEEDED

Our Canada Lake's Protective Association is always looking for volunteers. If you would like to help out, please call Lois Miller (835-6703), David Graves (835-2396) or any Chairperson.

Canada Lake Boat Parade



Sunday, July 20th
12:30-2:30

All Boats Welcome

*Classic, Decorated or
Just for Fun*

*Awards/Cocktail Party
Afterwards*

Check out page 12 of the current *Echo* or the CLPA board at the Canada Lake store in July for more details or contact Brian at BFranz@att.net

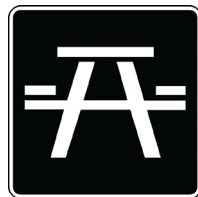

CLPA PICNIC

All members are invited to attend the 24th annual CLPA picnic. Please provide a covered dish to share, and you may want to bring your own folding chairs. The CLPA provides soda, beer, hamburgers and hotdogs. Volleyball and games for younger children are provided. This has proven to be an entertaining event for all generations attending. We urge all members and their families to join us at the 2014 picnic scheduled for 1 p.m., Saturday, July 26th at Warren and Josie Roosevelt's, 332 County Hwy 111 (London Bridge Road) on the bayou!

CLPA President's Message

The Echo has arrived . . . that unique booklet that puts smiles on all of our faces. The birth of *The Echo* happened in 1955. It was comprised of the famous Clare Dwiggin cover (still in use today) and two typed pages. You remember typewriters, right? We have certainly “come a long way” since that publication!

Speaking of remembering, all those that weathered the Northeast this past winter had a memorable few months with record low temperatures and plenty of ice on the lakes. Makes me wonder as I write this on March 21st if the ice will ever clear out of our lakes!

I remember small chunks of ice on the lake when I first arrived at Canada Lake in 1970 as a guest of the Bachman family on Dolgeville Point. I remember the first boat trip I took to journey to “The Point”. It was slow and cold but after that I was hooked. Today, the docks go in the day after the ice goes out and camp is opened with much enthusiasm. I so look forward to seeing all the great people of our lakes. I still say that the Canada Lakes are so special because the people of our lakes are so special.

Speaking of special people, I want to give a huge thanks to all the members who work so hard to make the CLPA such a successful organization. Whether you are an officer, a director, or a committee chairperson, whether you serve on a committee or you volunteer for one

of our programs, the CLPA could not function without you. Your support ensures the continuation of so many valuable programs, activities and events that bond our community together.

Thanks also to all of you who made generous donations toward a fireworks display this season. Yes, we will once again celebrate the 4th of July weekend with a BANG! To ensure a fireworks celebration for the 2015 season, the CLPA will need to continue to accept fireworks donations, preferably by check, at the Canada Lake Store or by check marked “Fireworks donation” and sent to: CLPA, PO Box 209, Caroga Lake, NY 12032.

Many other great events have additionally been scheduled for the 2014 season. These activities offer varied options for you and your whole family. This summer the CLPA will once again offer fun-filled times for young children, Tweens and Teens. The CLPA's Ladies Luncheon, Annual Picnic, Ice Cream Social and Annual Boat Parade are just a few of the scheduled events which offer a wonderful opportunity for you and your whole family to socialize with the Canada Lakes Community. Be sure to check the bulletin board outside the Canada Lake Store or check the CLPA website: <http://canadalake.mylaketown.com> for any updates associated with CLPA sponsored activities. I hope to see you at some or all of these events!

CLPA President's Message

Besides social events, the CLPA offers a number of programs which make our environment cleaner and safer. CLPA's Invasive Species Committee continues to be one of the most important committees we sponsor to ensure our lakes are clean. With invasive species in lakes all around us, it is vital that we continue to inspect watercrafts as well as educate boaters about preventing invasive species from entering our lakes. Please thank the volunteer lake stewards who give up their mornings or evenings to inspect watercraft at the West Lake boat launch. Better yet, join this committee and by working just a few hours this summer you can help ensure that our lakes remain invasive free. What's the saying: "Many hands make light work"? To find out more about volunteering to become a lake steward contact Mike Durkee (durkeeml@hotmail.com) or Jim Hays (jimhays@ldeo.columbia.edu).

Our Invasive Species Committee additionally has volunteers who inspect the shorelines of our lakes. Equipped with special rakes the volunteers dredge the bottom of our lakes close to the shoreline and determine what aquatic species are found. To find out more about volunteering to inspect our shorelines, contact Marcus Harazin (amichalek@capitalcardiology.com).

Another volunteering opportunity of a different type exists to help our community as well. This summer we will begin the latest update

of our CLPA Directory. This is the wonderful handbook of names, numbers and local information that allows us to contact each other at the lake and to stay in touch when we are away. The Directory came into existence in 1994 through a suggestion from Bill Peck that the CLPA should update John Fielding's 1978 Property Owner's Map. It has grown more interesting and varied with each edition. Anyone who would like to volunteer this summer to work on the latest update will be amazed at how much there is to learn about the people, the history and the activities on the lakes. Helping with the actual canvassing of residents is also a great way to spend a few hours outside getting to meet new and interesting people and really seeing all of the Canada Lakes! Our contact chairperson for the Directory is Dick Arthur (rarthur@nycap.rr.com) if you are interested.

The CLPA offers many other opportunities for volunteers to help in our community. Check the committees published in this Echo and see if there might be a place for you. Contact the chairperson of that committee(s) and become a part of our dedicated volunteer program. It is a great way to connect with this fabulous community.

I wish you and your whole family a wonderful summer and 2014. See you at the lakes!

Lois Miller

Schedule of Events: Summer 2014

June

- 22 (Sunday) Directors Meeting: 9 AM at the Miller camp
29 (Sunday) Youth Activities Organizational Meeting: Time TBA

July

- 5 (Saturday) Flares and Fireworks: 9:30 PM
12 (Saturday) Annual Meeting: Town Hall, 7 PM
16 (Wednesday) Ladies Luncheon: Pine Lake Paradise, 11:30 AM
20 (Sunday) Boat Parade: 12:30 PM - 2:30 PM
26 (Saturday) Annual CLPA Picnic: Roosevelt's

August

- 2 (Saturday) Amazing Race/Ice Cream Extravaganza: Alexander Camp, Time TBA
23 (Saturday) Directors meeting: Miller's camp, 9 PM
30 (Saturday) Flare lighting: 9 PM*

***Please wait for the island to be lit before lighting your flares – Thank you!**

Note: Check the bulletin board on the porch of the Canada Lake Store or the CLPA website at <http://canadalake.mylaketown.com> for the youth calendar, updates, times and additional activities.

Safe Boating Course: June 21st and July 12th
Call Town Hall at 835-4211 to register.



RECYCLE

First and third Friday of each month – put out by 6 am.

A Recycling Calendar & Recycling Guide is available at the Town Clerk's Office

Flare Safety

Just as you would attend a campfire, please be watchful when you light your flares for the 4th of July & Labor Day.

There have been incidences on the lake where docks have caught fire and sustained significant damage.

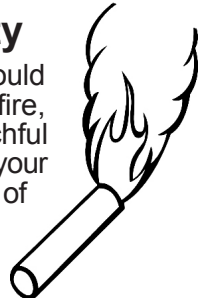

Environment and Ecology Report

The CLPA Environment and Ecology Committee held two meetings on July 13 and August 17, 2013 and discussed a range of issues of common interest. The group agreed that the CLPA website (<http://canadalake.mylaketown.com>) provides a great focal point for collecting and sharing access to helpful information for the lake community. The “Lake Issues” tab on the website now has useful information and web links on a range of topics including, but not limited to: results of the Canada Lake loon surveys, identification of invasive species, how to dissuade geese, or where to find low-impact outdoor lighting. As an example of what you can find on the site, under the “Lake Issues” tab you can find “Loons on Canada Lakes”. The information there ranges from how to minimize our impact on loons to how many loons were counted in the survey last year (nine) to a link of recordings of different loon calls and what they mean (http://blog.syracuse.com/indepth/2008/07/audio_hear_the_calls_of_the_co.html).

Special thanks go to Allen Farber for making this information easily accessible on the CLPA website.

Dave Graves

The Adirondack Committee

During the fall and winter the Adirondack Committee established contact with two Adirondack organizations. John Snyder attended a meeting in October of the Adirondack Lake Association, a loosely organized group of lake associations that meet from time to time to discuss issues of mutual interest. He gained useful information on boat washing stations and we plan to attend future meetings

The Adirondack Committee

of this organization in order to gain from their experience in ways that will help the CLPA.

Jim Hays has become a member of the Adirondack Invasive Plant Program’s committee of volunteers and attended a meeting of that committee in October. The thrust of a White Paper they are preparing is preventing the spread of invasive plants and animals from already infested water bodies. Everyone wants to guard their lake or river from invasive species but there is less incentive to take measures to prevent an infested water body from becoming a hub for further invasive spread. Effective invasive control must include decontamination of boats leaving infested water bodies.

Jim Hayes

Invasive Species Report

Protecting the Canada Lakes from invasive plants and animals is everyone’s responsibility! Boats used on other water bodies should be cleaned before leaving those shores and launched on the Canada Lakes.

While we are not able to inspect every boat launched at the West Lake Boat Launch, we educate most of the boaters that use the launch.

Last summer two paid and eighteen volunteer Lake Stewards inspected some 690 boats and talked to over 1770 boaters at the Boat Launch. These totals are about 10% below the 2012 season. Of the boats inspected, over 100 had previously been on water bodies containing invasive plant or animal species, with the largest number coming from the Sacandagas and the Mohawk River.

Invasive Species Report

Vegetation was removed from 31 boats or trailers including Water Chestnut seeds, however, the vast majority of boaters were aware of the need to keep their boats and equipment clean. Our efforts will be reinforced when the NYS Department of Environmental Conservation issues the new regulations banning the transport of invasive species and their introduction into the waters of the state. (The proposed regulations can be found on the DEC website.)

Our Lake Stewards cover the Boat Launch from Memorial Day weekend to Labor Day weekend. We have a steward on duty each Saturday and Sunday in June, and as many days as possible in July and August up to the Labor Day weekend. Each volunteer steward usually serves two 3-4 hour Friday evening or Saturday/Sunday morning shifts each season. More volunteers are needed, if interested please contact Mike Durkee (durkeeml@hotmail.com). A half-day training session is provided in June.

Every year more Adirondack lakes are found to have invasive species, and removal or remediation is difficult and expensive, as our neighbors on the Caroga Lakes have found.

Last July, under a contract with the CLPA, the Darrin Fresh Water Institute of Bolton's Landing performed a systematic survey of the Canada Lakes, taking samples at over 200 stations. In their report of October 15, 2013, the researchers provided the following conclusion:

"All species reported are native to our region, with no exotic or invasive species encountered. The total number of aquatic species for the three lakes was 30, 33, and 19, for Canada Lake, West 11

Lake and Green Lake, respectively. This number of species greatly exceeds the 15 species typically reported in moderately productive lakes in New York and indicates good water quality and a variety of habitat types."

A web version of this species list, with photographs, can be found at: http://employees.oneonta.edu/farberas/arth/lake/aquatic_species.html

In August, our twenty one volunteer Lake Inspectors searched the shallow waters along most of the Canada Lake's shorelines and found no invasive species (see <http://canadalake.mylaketown.com/invasive>). More volunteer inspectors are needed to cover all areas. If you are interested in helping please contact Marcus Hazarin ("Marcus Harazin" <harazm@sage.edu>). A one half-day training session is provided in late June and a field trip to Caroga Lake to observe invasive plants in late July.

The Invasive Species Committee is grateful for the continuing monetary support of the Town of Caroga, the CLPA, and individual CLPA members. Last year's individual member contributions were used to help defray the expense of the aquatic plant survey. Particular thanks go to Neil Kasson and Cathy and Don Gardner, our last year's paid stewards, to Bill and Dorothy Fielding for handling the payroll and to all our volunteers.

Jim Hays

**FISH CATCHES
PLEASE REPORT YOUR FISH
CATCHES AT THE STORE.
YOU DON'T HAVE TO TELL
WHERE YOU CAUGHT THEM,
JUST THE SIZE.**

The CLPA Boat Parade Returns

The annual Canada Lake Boat Parade was resurrected on Sunday, July 21st of 2013. Participating boats gathered in front of Carole Fisher's camp on the South Shore where boaters signed in and received their numbers. The 2013 parade was dedicated to the memory of Dave Fisher, an avid wooden boat enthusiast and friend to many.



Approximately 35 boats were in the parade. At the designated time, participants formed a line and proceeded around both Canada Lake and West Lake. Many boats were decorated for the occasion and many people cheered from their docks as the boats passed by. Some onlookers even joined in the parade as it went by their camps. After the boats rounded the lake, a reception and awards ceremony was held at Kristin and Brian Franz's Camp with appetizers, beverages and a reproduction of Jack Ryan's famous "Fish House Punch" from old CLSC parties. A great time was had by all!



Each year one boat is chosen as the winner of the Champion's Trophy. Master woodworker, Edwin Woods, designed and built the perpetual CLPA Boat Parade trophy. The winner of the 2013 trophy was the Silvernail-Woods Camp for their



The CLPA Boat Parade Returns

“Christmas in July” theme. They are the trophy holders until the next boat parade when it will be relinquished to the 2014 champion.

Honorable Mentions were given for two boats in the 2013 parade. One was awarded to “Bear Naked” featuring Dylan, Wesley and Harrison Franz and their guests Kendall and Jake Armstrong. The theme was a tribute to Arden Zipp whom many remember from the boat parades of years past because of the infamous stuffed bear on his boat. Another Honorable Mention went to Pete and Lauren Lozier who were dressed in their wedding attire as they celebrated their anniversary in a classic jet boat. In addition, judges awarded each participating boat a “CLPA Boat Parade” ribbon for joining in the festivities.

It is now time to start planning your creative boat-theme ideas for this year. The 2014 boat parade will be held on Sunday, July 20th from 12:30-2:30. It will be similar to last year’s parade as the rendezvous point will again be Carole Fisher’s camp at 172 South Shore Road. In addition, a post-parade reception will follow at Brian and Kristin Franz’s camp at 272 South Shore Road. We all look forward to the waves and cheers from the docks and seeing the participating boats pass by, whether decorated or not.

See you on the lake!

Kristin Franz



STOP AQUATIC HITCHHIKERS!™

Prevent the transport of nuisance species.
Clean all recreational equipment.

www.ProtectYourWaters.net

When you leave a body of water:

- Remove any visible mud, plants, fish or animals before transporting equipment.
- Eliminate water from equipment before transporting.
- Clean and dry anything that comes into contact with water (boats, trailers, equipment, clothing, dogs, etc.).
- Never release plants, fish or animals into a body of water unless they came out of that body of water.

Calling all knitters, crocheters and needleworkers

Come join the fun at our knitting, crocheting and needlework group! Both men and women are welcome.

We meet on Tuesdays from 1-4:00 pm at each other’s homes or camps. If interested, please contact any of the following ladies for further details:

Phyllis Sandford
(518) 835-2264

Judy Aldinger
(518) 835-6695

Lisa Bates
(518) 439-3822

Canada Lake Sailing Club - Summer 2014

Detailed Event Schedule

Membership: Membership is by family and is \$10 for the 2014 season. The fee covers one or more boats. Please make checks payable to: *Canada Lake Sailing Club*. Mail payments to: Court Young - CLSC, Box 825, Caroga Lake, NY 12032. This is a change from previous years.

Sailing Lessons: “Private” lessons will be available. Call Court at 518-835-3701 for details.

Sailing Clinics: Clinics are open to all registered family members. Call Court at 518-835-3701 for further information. A very successful four day clinic was held in July 2013. **See photo!**



“Get Out & Sail” Events: Two informal events are planned below. There will be no rules or scoring for these events.



- **July 4th (2-4 pm):** A casual sailing event with family and friends. Wind permitting sail from your dock once or twice around the island. Show off your boat to the Canada Lake community and take a kid or a senior along as your crew!
- **August 1st (3-6 pm):** Sail from your dock to Court Young’s dock and then on to Franz Port.

A special “award” awaits those who come within an arm’s reach of Court’s dock and another special “award” will be given for sailors and crew who reach Franz Port

Saturday Racing: Held every Saturday at 2 pm starting at Franz Port. Any type of sailboat can race. The ‘Sunfish’ class will continue but an ‘Open’ class will also

be offered. All sailboats are eligible but families should be registered to participate.

Après Race Social: Meet at the Franz Port dock for a “debriefing” with drinks and snacks.

Traditional Sailing Parties:

- **July 5th at 9 am:** Breakfast and meeting at 137 Dolgeville Point.
- **July 30th at 5 pm:** Drinks and snacks at 137 Dolgeville Point.
- **August 24th at 5 pm:** Drinks and an informal dinner meeting at 137 Dolgeville Point. The Dave Fisher Memorial Trophy for the “Most Improved Sailor” will be awarded at this meeting. (Rumor has it that the ancient tradition of serving “Fish House Punch” will continue at this event...)

Summary of the 2014 Season Schedule:

**Get Out and Sail
July 4th & August 1st**

**Lessons
At your convenience**

**Clinics
To be announced by phone
and/or email**

**Racing
Saturdays at 2 pm from
Franz Port**

**Parties
July 5th & 30th; August 24th**

**CLSC THEME FOR 2014...
“TAKE A KID SAILING”**



Wear Requirements for Personal Flotation Devices

The following persons must wear a Type I, II, III or V PFD of proper size and serviceable condition:

- Children under the age of twelve unless they are in a fully enclosed cabin. The PFD must be the appropriate size for the child.
- Anyone operating or riding on a personal watercraft (Jet Ski, Wave Runner, or similar craft)
- Anyone being towed behind another vessel such as waterskiers, tubers, para-sailing, etc. You are exempt if you are on a disabled vessel and being towed.
- Anyone riding in a pleasure vessel less than twenty-one feet, including rowboats, canoes, and kayaks, between November first and May first.

REMEMBER!!

**A non-motorized craft
always has the right-of-way**



CAROGA HISTORICAL MUSEUM

carogamuseum.org • (518) 835-4400
145 London Bridge Road / PO Box 434, Caroga Lake, NY 12032
Open Thursday through Sunday 1 to 4pm
June 27th through September 1st

CALENDAR OF EVENTS – 2014

SPECIAL EVENTS

- JUNE 26** 7 PM – 9 PM **MUSEUM OPENS**
Sherman Arcade Reopening
Welcome reception
- JULY 10*** 7 PM – 9 PM **CONCERT: "DICK SOLBERG SUN MOUNTAIN FIDDLER"**
Caroga Chapel – St. Hwy. 10
Good will offering
- JULY 19** 10 AM – 3 PM **CRAFT FAIR**
Crafters, Bake Sale, Raffles (drawing at 2 pm)
Food 11am – 3 pm
Weaving demonstration – Eileen Wrightsman
Music – Durey Creek Bluegrass Band – 11 am – 2 pm
- AUGUST 1*** 8 PM – 11 PM **MUSIC&DANCING: "SWING DOCS"**
Renowned band of professionals from Albany Medical Center
Swing, big band and rock selections
Performance held at Adirondack Paradise
St. Hwy. 29A and 10, Pine Lake
Admission \$12 p/p at the door
Refreshments will be available for purchase
- AUGUST 7** 7 AM – 9 PM **GALLERY OPENING: PHOTOGRAPHY**
Welcome reception – August featured artist – Darla Oathout
Slide presentation – "A Photographer's Journey"
Exhibit runs from August 7th through August 31st
- AUGUST 9** 4 PM – 7 PM **BROOKS CHICKEN BARBECUE**
Eat on grounds or take out
Tickets available at museum - \$12 p/p
Presale tickets recommended
Call the museum (835-4400) for tickets
Walk-ins welcome

Continued →

WORKSHOPS

- JULY 17** 10 AM - 3 PM **DEMONSTRATING HOMEMADE RUSTIC PICTURE FRAMING**
TOM HEALEY
Bring lunch only
Class limited to 8
- JULY 24** 10 AM - 3 PM **BASKET WEAVING**
EILEEN WRIGHTSMAN
Bring lunch, shears, measuring tape, clothespins, awl, small tub, pencil & \$22.00 for materials.
Class limited to 12
- JULY 31** 10 AM - 3 PM **QUILTING**
DIANE HENDERSON
Bring lunch, shears, needles, white thread & \$5 for materials. Class limited to 10
- AUGUST 7** 10 AM - 3 PM **PAINTING PUMPKINS ON TIN**
PHYLLIS SANFORD
Bring lunch & \$10.00 for materials
Class limited to 12
- AUGUST 14** 10 AM - 2 PM **CORN HUSK DOLLS, WREATHS AND FLOWERS**
JEANNINE SCHWARTZ
Bring lunch, needle nose pliers with cutter, 10" straw & wreath & \$12.00 for materials.
Class limited to 8
- AUGUST 21** 10 AM - 3 PM **"DESIGN YOUR OWN NOTE CARDS"**
BARBARA MICHAELS & JUDY ALDINGER
Create, Make & Take
Bring lunch, scissors, colored pencils and \$10 for materials
Class limited to 10

The registration fee for each workshop is \$20.00 for members and \$25.00 for non-members. Send your check (**payable to Caroga Historical Museum**) for the **REGISTRATION FEE ONLY** with your name, address and phone number to:

Sue Tantalo
P. O. Box 1038
Caroga Lake, NY 12032

For additional information on the workshops call Sue at (518) 835-2733.

State of the Arts



SARATOGA ARTS
ARTS CENTER | ARTS COUNCIL

NYSCA

* This program received support from Fulton-Montgomery Arts Grants, which is made possible by the New York State Council on the Arts with the support of Governor Andrew Cuomo and the New York State Legislature and Saratoga Arts.

Canada Lake Store & Marine News

Today we were greeted by another sub-zero morning of -18 degrees on March 6th. To put this in perspective, an official from the National Climatic Data Center remarked that "only 32 winters have been colder in the last 119 years." Although it has been this harsh, people have been able to enjoy almost every winter sport, including skate skiing on a track Bret maintained on the lake. The Canada Lake Store & Marine

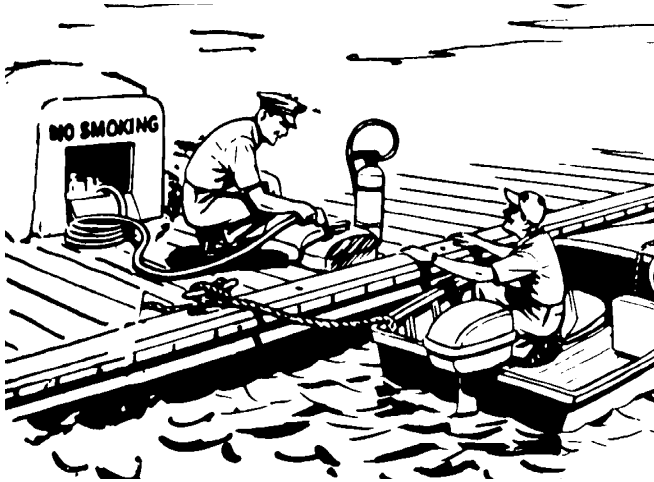

won the annual Outhouse Race competition in February, thanks to our strong team of Sam Lee, Howard Dutcher, Nathan Dutcher, John Byrnes, Bret and our excellent outhouse.

Over the winter Howard Dutcher and Chris Piehuta have had plenty of marine projects to undertake as well as attending Mercury School in January to keep current in their field. Preparing for The Great Upstate Boat Show at the end of March is the main focus for Bret this month. During the off season Hope Piehuta

has been engaged in projects for both the marine department and the store. Chris Stevens from Pine Lake will be assisting us especially when the boats go in and out of storage.

This year we hope to entice you with several new food items like locally made 100% natural Adirondack Jack Saratoga Peanut Butter for one and Gatherer's Gourmet Granola. In the gift area we'll feature new items such as laser etched custom wooden and ceramic gifts and souvenirs and unique topo map slate trivets. We will continue to retail smoked meats and cheeses from Oscar's Smokehouse and provide a weekly selection of fresh fish with a preorder delivered on Thursdays. Adding more healthy products with natural ingredients including gluten-free and organic choices will be a main objective as well.

SUP's, short for Stand Up Paddleboards, have become a very popular way to get exercise on the water and are available here for rent or for sale. Also our exciting O'Brien products offer something for everyone who loves to spend time on the water behind a boat.

This season you will be greeted by these friendly new employees. Please introduce yourself to them when you get a chance.

Continued →

Canada Lake Store & Marine News

Andrew Camarra	West Lake Johnstown, NY
Kristen Cannon	Canada Lake East Setauket, NY
Kristen Dupuis	Caroga Lake
Dominique Egan	Canada Lake Naples, FL
Stephanie Grillot	Pleasant Lake Poughkeepsie, NY
Abigail Heroth	Pine Lake Johnstown, NY
Emma Heroth	Pine Lake Johnstown, NY
Jonathan Heroth	Pine Lake Johnstown, NY
Aubrey Kamppila	Canada Lake Burnt Hills, NY
Daniel Nellis IV	Caroga Lake
Raymond Nellis	Caroga Lake
Margaret Newell	Canada Lake Lexington, KY
Mary Offutt	Canada Lake Sterling, VA
Matthew Sagan	Johnstown, NY

Three of our four children are now settled in this area all year round. Eric, Jess, and Embree are now in their new home on Green Lake. Merryn, John, Anika, Kaelyn, Bret and Sam are living on Canada Lake.

Heather will return from Utah to operate The Lake Effect Café starting Memorial Day Weekend. Sam has established an acupuncture business, High Peak Acupuncture, next to the store and is welcoming new clients. Thankfully, Merryn is devoted to training our new employees, keeping up with ordering and inventories, and providing technical support when needed.

We are so pleased to continue to offer our patrons a little more than a convenience store and are very grateful for all of the support you give us each year in both facets of our business. Let's hope that Mother Nature delivers a spectacular summer for everyone.

Bill & Dorothy

2014 INFORMATIONAL GUIDE FOR THE TOWN OF CAROGA

The Town of Caroga's codes, permit requirements, tax information, garbage and recycling pickup times, transfer station information, and other valuable local services and events are available to you!

This information and more can be found in the Town of Caroga 2014 Directory. Copies are available at Town Hall, the Post Office or on the town website <http://www.carogalakeny.com>.

Fishing 2014

Fishing is one of the keenest and best pleasures in life. About forty percent of all fish are fresh water species. Common species that are in our lakes are large and small mouth bass, pan fish, fall fish (shiners), pickerel, catfish, rainbow, brook, and lake trout. There are many fishing techniques including a variety of live baits and lures. With all these possibilities, there is something for everyone. What are you waiting for? Have a great summer.

*John Plantz
Fishing Chair Person*

Ski Committee

We had approximately twenty people of all ages, including three adult students, participate in the clinic this year. The majority were wakeboard/skurfing candidates with about a half dozen water skiers included in that number. Thanks go out to the Studenic camp for loaning us Matt and Amanda and their red Moomba to help out. Linda Clark and John Olm graciously assisted us once again and kept the boarders happy with their Moomba-made wake. Dylan and Wesley helped out with their Mastercraft and our boat served as the beginning/slalom ski boat with Lauren Lozier assisting Ed. Thankfully the weather cooperated and everyone got all of their runs in and left tired but happy.

Linda

Ladies on the Lake Luncheon

The 2013 Ladies Luncheon was an exceptionally successful event. We doubled the money we raised from last year, many women attended and a wonderful time was had by all. The Luncheon had moved to a new venue, The Pine Lake Paradise Lounge. The owner of the lounge, Jeff Houck, and his staff did an incredible job providing us with a delicious meal and plenty of space for our auction. Thanks to the generous donations from local businesses and artists we were able to raise over \$450.00 for the fireworks display and we increased our donation to the food pantry to \$100.00.

This year's Luncheon will be held on Wednesday, July 16th at 11:30am and we're looking forward to another fun gathering with the CLPA Ladies. The success of the Ladies Luncheon is due to the dedication of the fabulous committee members who give so much of their time to make sure this event goes off without any issues. I want to personally thank all of these women and I want them to know it is truly appreciated!

Maureen

***See All
the Pictures
on the
Next Page!***

**Ladies
on
the
Lake
Luncheon**



IMAGES
FROM THE
2013
ANNUAL PICNIC



Continued



New York Paradise

When most people think of paradise, they think of warm, sandy beaches near the equator. When I think of paradise, I think of my grandparents' house in upstate New York. My paradise resides in the Adirondacks on Canada Lake.

While I love being at Canada Lake, the six hour car drive is not the greatest. My family and I have made this trip countless times due to the fact that we have been going there our whole lives. Our trips consisted, and still consists, of five bathroom stops, one fast food meal, two movies, our movies of choice being Disney movies and *Cats and Dogs*, and at least a nap or two.

As a kid, this six hour trip seemed more like twelve hours, especially when my dad would not stop when I had to go to the bathroom! I remember once when I was about thirteen, I warned my dad I had to go to the bathroom. He acknowledged me, but then acted as if he forgot. I saw a sign that said a rest stop was only five miles away. Five miles at maybe 60 miles per hour meant I only had to wait about five minutes. Five minutes later, we passed the rest stop. I began to panic and asked my dad why we did not stop. He said we would get the next stop. Another five minutes later we pulled off of the highway and entered a gas station. I ran in and frantically searched for the bathroom. When I asked him why we did not stop at the first rest stop, he said it was

because this gas station had better peanuts. I almost urinated in the car because my dad wanted good peanuts. We laughed and I jokingly acted angry as we headed back towards the car and continued on our way. The car rides were tough, but we always managed to have fun spirits on our way to our favorite place on earth.

As soon as we got there, we were greeted by my grandparents, they helped us take our luggage in, and my sisters and I raced up the stairs to claim the "peach room". There are three possible beds for us: the peach room, the green room, and the purple room. The purple room is normally claimed by my parents and the green room is usually inhabited by any aunts and uncles that are up the same time we are, so the peach room is the kid's room. The peach room also has the softest bed, so we love being in there. Each time we get there, it's always the same, but never less exciting than the last.

My mom spent all of her summers there as a child, and she wanted her children to have the same experiences she had: water skiing in the morning before the waves start, going to the lake store for lunch, and riding sunset cruises in the late afternoon. Unlike my mom, we do not spend our whole summer at Canada Lake, but we go up there several times throughout the summer. Each year, we make more and more memories.

New York Paradise

My earliest memory from Canada Lake was visiting “Barney Island”. My sisters and I named it “Barney Island” after a Barney movie called Imagination Island. In the middle of the lake, about twenty trees and large rocks that jut out from the side of the island. My parents took my sisters and me out to the island in our then new pontoon boat, tied it to the small dock on the island, and we raced through the short pathway to get to the rocks. Back then, the rocks looked like small mountains that we climbed, leaped, and skipped over. We trudged our way past thirty some rocks before we reached the farthest most rock where we sat and gazed upon the shoreline in all directions looking at all of the different houses on the lake. Some weren’t even houses; they’re more like campers or cabins. They’re small wooden structures, most with one, tiny bathroom and an open upstairs loft. Cabins built tens, maybe even hundreds of years ago somehow still stand strong. Strong like the hefty mountains behind them.

The view at the lake is another element that adds to the overall feeling of paradise. Even though there are only a couple of sunny days a week, I soak them up as much as possible. I spend these glorious days on the chaise lounge taking in the sun rays, tanning in the middle of the lake on the back of our speed boat, or out playing on the water.

Just a couple of summers ago, I learned how to wakeboard. We rented a wakeboard from the lake store for a day and went straight to the water. While my older sister Allison had prior experience wakeboarding, I had none. She showed me a couple tips, and I was out to try it on my own. After strapping both feet onto the board, I jumped in the water. As I bobbed in the water, I took hold of the ski rope and waited for the boat to get far enough away so that the rope was taut. I told my dad to “hit it” which meant I was ready, and the boat took off. I pushed the board against the water, tried to turn it 90 degrees, and the boat pulled my top half right over the board. I face-planted into the water. My adrenaline made the fall seem less impactful. I laughed as I pictured my own epic failure in my head and as the boat pulled around, I was ready to try again. The next time after my dad “hit it” I learned from my mistakes and I successfully got up. Since, I have really enjoyed wakeboarding, and other than little hops over waves and the wake, I am not aiming to do any fancy tricks like some of my lake friends.

My friends up at the lake also make Canada Lake my favorite place on earth. Even though I have been going to the lake since I was born, and so have they, I only met them two years ago. Allison started meeting some kids her age, and those friends had little sisters that were my and my younger sister

New York Paradise

Jenn's age. We started hanging out and quickly joined their preexisting group of lake friends. There's Maggie, who likes to argue with people in Spanish, listen to podcasts in her free time, and continuously make us laugh with her witty puns and awkwardness. There's Kristen, who has a strong New York accent and is always the one to instigate fun plans. There's Annie, who is so happy-go-lucky and is pleased with the simplest things, like playing cards on a rainy day. And there's Dylan and Wesley, the only two boys in the group who are brothers, yet very different. Dylan is the older, wiser brother who enjoys talking about psychology and pointing out the funny mistakes no one else catches. Wesley is the youngest in the group as well as the most energetic. He's the jokester and always makes our plans more exciting. All of our different personalities mesh together perfectly and there is never a dull moment between us. Coincidentally, whenever my mom was a kid at the lake, she hung out with Dylan and Wesley's dad, and Kristen's dad and uncle.

Canada Lake is full of smiles and adventure. Even on the rainy days, playing cards with my mom and grandma is still pleasurable. No matter what I'm doing, rain or shine, I still feel like I am in paradise. As I wake up to the sun shining through the blinds and birds chirping as my alarm, I am overwhelmed with peace and serenity. Our house on the lake

will hopefully remain in our family for years to come so I can take my children to see their grandparents over the summer. My children can hang out with Maggie's, Kristen's, Annie's, Dylan's, and Wesley's children as well as their cousins. They would do this just as my mom did, and just as I do now. The lake house brings my family together in a joyous environment, and it is my paradise.

Katie Dykeman

Lending Library

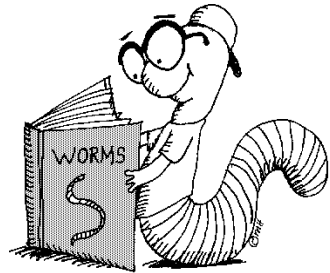

Year Round Stop by the lobby of Caroga's Town hall and pick up or drop off a Book or two.....

PLEASE...

Post your House Number!

If you are unsure of your 911 # Call the Fulton County Sheriff's Department at (518) 736-2100

The Counties enhanced system assists emergency personnel to your location when dialed from a land line.

NEW GARBAGE SCHEDULE

Summer Garbage pickup is on Tuesdays from May 1st to September 30th

Beginning October 1st - through April 30th Garbage will be picked up MONDAYS

Garbage to be curbside by 6 am on day of collection in clear plastic bags

Do not include any recyclables, or yard debris

Residents are encouraged to place garbage in a trash can with handle locks - up to 20 gallons in size

Paint cans without lids may be placed in a separate plastic bag curbside if they are empty and dry

FIRE TIPS

- Have at least one fire extinguisher per building.
- Have a hose, with nozzle, hooked up to an outside faucet.
- Know where the nearest fire pump (red box) is located.
 - *Sonnenberg's at 624 West Lake Rd*
 - *Dennie's at 342 South Shore Trail*
 - *Lichtneger's dock at 206 Dolgeville Point*
 - *In Bill Fielding's work boat*
- Know how to operate these pumps or ask any director for instructions.
- Call 911 for the Fire Department.
- Know your House number when you call.

The Man from Canada Lake

My mother does very well for herself. Out of respect to her personal sensibilities we won't discuss her age, but suffice it to say she's pretty amazing. She drives locally around Johnstown going about her business, attending mass, and visiting her children. If conditions are perfect on a spring or summer Sunday she'll venture up to Green Lake for quick visit with me, my wife and our friends. She always brings along her homemade pizza fresh out of the oven and ginger ale.

Last year Mom was anxious to relate an experience she had in town.

It was Sunday, Mother's Day. She was at a convenience store to gas her car up and had gone into the store to be sure she got her gas discount. As she was making her way back to the car a gentleman approached her, making a brief introduction. He explained that his mother lived out of town and he was unable to spend Mother's Day with her. Would Mom object to his doing the service of dispensing her gas as a kind of homage to his own mother?

During their brief conversation the man said he was living at Canada Lake. She didn't recall his name.

This little act reflected well on all of us as children and lake denizens. It thrilled and impressed Mom and made her day. Thanks, whoever you are.

Joe Santangelo

Prevent the Spread of Aquatic Invasives

The following information comes from the New York State Department of Environmental Conservation



STOP AQUATIC HITCHHIKERS!™

Boats, trailers, waders and other fishing and boating equipment can spread aquatic invasive species from waterbody to waterbody unless properly cleaned, dried or disinfected after use. Although some invasive species such as water milfoil are readily visible to the human eye, many others are too small to be readily noticed. To avoid spreading invasive species please follow the guidelines in the following steps:

1. *Check*
2. *Clean*
3. *Drain*
4. *Dry*
5. *Disinfect*

Check

Check your boating and fishing equipment for invasive species.



Investigators checking a boat for invasive plants.

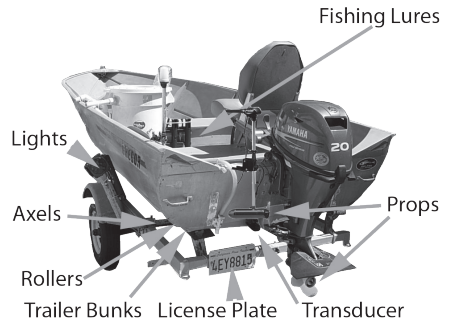

Be sure to carefully examine these common invasive species attachment points.



Don't forget to also inspect all gear used during your fishing or boating trip.

Prevent the Spread of Aquatic Invasives

If your boat has been used in a water containing zebra mussels, run your hand along the hull. If it feels like sandpaper, it likely has mussels attached.



Photo courtesy of Utah DWR.

Clean

Clean any visible mud, plants, fish or animals before transporting equipment.



Remove all invasive species from your boat and equipment.



Don't forget equipment such as anchors and other gear.

Discard items in an upland area or in one of the invasive species disposal stations that have been installed at many boat launch sites for your convenience.



Zebra mussels can be difficult to remove from a boat hull. They first need to be killed by exposure to water or steam at least 140 degrees F and then removed by brush or pressure washer.



Photo courtesy of Utah DWR.

Drain

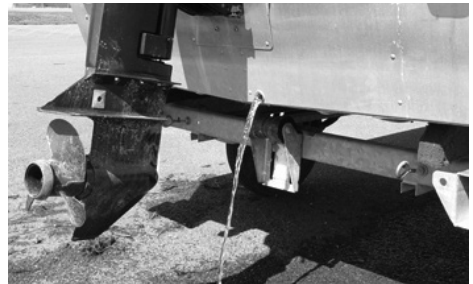

Drain your boat before you leave the access site!

Prevent the Spread of Aquatic Invasives

Drain all water holding compartments including live wells, bait wells and bilge areas.



Be sure to drain boat ballast tanks if your waterski or wakeboard has them.



Drain your livewell if you have one.

Dry

Dry boats, trailers and all equipment before use in another waterbody.



Drying your boat takes at least 5-7 days in dry, warm weather.

The most effective method to ensure that no invasive species or fish diseases

are transported to a new body of water is to completely dry your boating and fishing equipment. The key is to make certain that equipment is COMPLETELY dry before using it in a new water body. Drying times vary significantly depending upon the type of equipment, air temperature and relative humidity. While the outside of a boat will dry relatively rapidly, bilge, live wells and other areas of a boat not reached by the sun or lacking good air circulation will take additional time to dry completely. A minimum of 5-7 days drying time in dry, warm conditions is recommended. Drying times can be estimated at <http://www.100thmeridian.org/Emersion.asp>.

Disinfect

Disinfect anything that came into contact with water, if it cannot be dried before reuse.

Disinfection Techniques for Fishing and Boating Equipment

If your boating and fishing equipment cannot be dried before its use in another body of water, it must be disinfected. Disinfection recommendations vary depending on the type of equipment and disease of concern. Be particularly aware of bilge areas, livewells and baitwells in boats. These areas are difficult to dry and can harbor invasive species. A summary of recommended cleaning materials and techniques are provided below.

Prevent the Spread of Aquatic Invasives

Effective Disinfection Techniques Include

Hot Water: Hot water is an effective disinfection agent for all aquatic invasive species and fish diseases. While many of the invasive clam and mussel species can detect other disinfection agents and avoid them by tightly closing their shells, they cannot protect themselves from the effects of high temperature. Soak all equipment in water kept above



140°F (hotter than most tap water) for 10 minutes or for 20 minutes in water that is at least 110°F. Note that hot water can delaminate Gore-Tex® fabric and damage other sensitive clothing items. Household steamers may also be used for disinfection by exposing equipment to steam for 10 minutes. Some commercial hot-water car washes can be effective for disinfecting boats and vehicles, but many do not heat water hot enough for proper disinfection.

Bleach: Bleach is also a very effective disinfectant agent, but it is a caustic substance that can be corrosive to aluminum and other sensitive fishing and boating equipment. Soak or spray

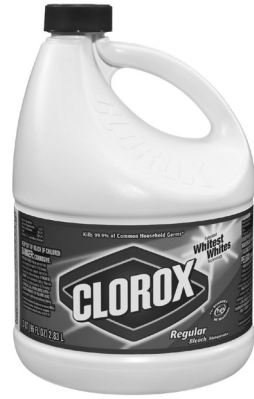

equipment for at least one minute with a 2% bleach solution (3 ounces of household bleach mixed with 1 gallon of water). If whirling disease is suspected, a 10% solution should be used (13 ounces of household bleach mixed with 1 gallon of water).

Potassium Chloride: Commonly used as a substitute for calcium chloride in home water softeners, potassium chloride (KCL) is a very effective cleanser for boats and equipment used in waters containing zebra or quagga mussels. It also does not have the corrosive side effects of some other cleaning agents.

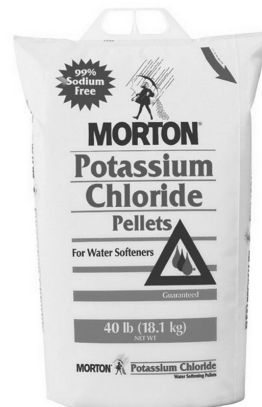

Prevent the Spread of Aquatic Invasives

A 200 ppm solution is recommended (one teaspoon of dry KCL salt crystals in 2 gallons of water). KCL salt crystals can be purchased at any home improvement or hardware store selling water conditioning products. Given the non-corrosive attributes of KCL, it is particularly useful in cleaning engine cooling systems and other corrosion prone areas.

Cleaning Agents: Of the materials traditionally used to disinfect for human or animal health purposes, quaternary ammonium compounds have been found to be effective in controlling fish viruses and pathogens, including whirling disease. Commercial formulations, such as Parvasol® and Kennelsol®, are available through laboratory or veterinary supply companies. Household cleansers/disinfectants, such as Formula 409® and Fantastic®, that contain the quaternary ammonium compound alkyl dimethyl benzyl ammonium chloride can also be used to disinfect

to soak equipment for a minimum of 10 minutes. Be sure to dispose of materials away from surface waters in accordance with label restrictions.

Special Note to Wading Anglers: Felt-soled waders and wading shoes, which have been identified as an important means by which whirling disease spores and didymo can be transported, are difficult to disinfect. Rubber or studded soles are now readily available that provide similar traction, and are much less likely to transport these invasives.

For an in depth description of how to clean, dry and disinfect various boats and boating equipment download the following from the DEC web site <http://www.dec.ny.gov>

A New York Boaters Guide to Cleaning, Drying and Disinfecting Boating Equipment

A New York Boaters Guide to Cleaning, Drying and Disinfecting Boating Equipment

Procedures To Prevent the Spread of Aquatic Invasive Species While Boating



New York State Department of Environmental Conservation
www.dec.ny.gov

ACTIVE INGREDIENTS:	
Alkyl (C12 40%; C14 50%; C16 10%) dimethyl benzyl ammonium chloride	0.3%
OTHER INGREDIENTS.....	99.7%

Look for disinfectants that contain alkyl dimethyl benzyl ammonium chloride.

equipment. These solutions can be used full strength as a spray, or diluted for soaking with 2 parts water to 1 part disinfectant. For all materials, follow label instructions and be sure

Summer Recreation Program

July 7 – August 15

The Town of Caroga, in conjunction with the Wheelerville School, sponsors a summer recreation program for children of residents and summer residents of the Town of Caroga.

Children who have completed kindergarten and up to age 13 are invited to attend the program.

There is no cost to attend and regular attendance is not mandatory. A bus picks the children up and returns them to the Wheelerville School each sunny day; on rainy days recreation will be held at an indoor location. The program includes arts and crafts, sports, games, and field trips.

Contact the Wheelerville School at 835 - 2171 for more information.

PERSONAL WATERCRAFT

- Each person on or being towed must wear a life jacket (PFD).
- The PWC must have a USCG approved backfire flame arrestor.
- If so equipped, the engine cutoff lanyard must be used.
- No operation between sunset and sunrise.
- No PWC may be operated within 500 ft. of a designated swimming area except when launching and then 10 MPH (straight out).
- Safety equipment such as a distress signal or horn must be on board.
- New York State Law prohibits:
 - weaving in and out of traffic
 - intentional last minute swerving except to avoid collision
 - wave jumping
- Anyone operating a PWC in New York State must complete a safe boating course.
- The minimum age for operating a PWC is 14 if the operator holds a safety certificate.
- Underage riders who have earned a boating safety certification may operate a PWC if accompanied by someone 18 or older who is the holder of a boating safety cert. and is on either a PWC or motorboat within 500 ft & within sight of the underage operator.

Blast From The Past!

I first started designing the Echo in 2003, basically since I worked in the field and my mother, the former Echo editor and chief told me I have no choice, I have been happily doing it ever since.

One thing I miss from those early issues was the crossword, so I thought I would add the crossword and word search from that year, enjoy! - *Mark Moritz*

Be Advised This is From The 2003 Echo When Doing the Crossword

DOWN

1. 1150 to Caesar
2. Notre Dame coach, NFL hall of famer _____ Parseghian.
3. See one, "pick it up, and all day you'll have good luck":
4. Victorians called it a "limb."
5. Messrs. Foster, Pawlows and Younglove of Canada Lake.
6. Bad news from the dentist.
7. Large WW II amphibious craft (pl.).
8. Organization of U.S. water specialists (abbr.)
9. Poisonous spring wildflower with an edible fruit.
10. A crayfish's antenna.
11. Loafer.
12. Internet lingo for "anyone."
13. Family of Caroga contractor.
18. German Grandma.
22. Acronym for a popular pancake restaurant.
23. Term for what we now call jerks.
24. _____ Ben, the rice man; _____ Miltie, the comedian; or _____ Tom of cabin fame.
25. Wanders.
26. Final syllable that changes a cart, ball or a drag into other things.
27. The mesdames Andrews, Chace, Peck and Tantalo of Canada Lake.
30. "Tippecanoe and _____ too"
33. England is the Queen's
34. What friends call Mrs. Collins of 202 S. Shore Rd.
35. _____ abbreviations before names of Byrd, Daschle, Frist, McCain, Clinton or Schumer
37. Canada Lake Store is a _____ of groceries.
38. Consumer of a service.
39. What they do at the Nick Stoner.
41. Sword or wrapping material..
42. _____ fish (var.) Jewish dish.
43. The people at 168 Barbour Rd.
44. Puts a gloss on.
46. Henry and Nancy, of 107 Hutchinson Rd.
47. Spooky.
48. Another name for Greek isle, Aegina.
50. Abbr. for a formal group (often used on Internet)
52. Echo's new editor.
55. Town in Yell County, Ark
56. A plural word for mouth, used mainly in science and medicine.
57. Option for non-meat eaters (abbr.).
58. Long, thin fish, delicacy in Europe and Asia.
59. Society of graduate women in science (3 Greek initials)

(Solution on inside back cover.)

Word Search



CANADA
SAILING
SAILOR
LOON
BEAR
DEER
LIFE JACKET
CAROGA
ADIRONDACK
BOAT
BEACH
RACoon
LAKE
ECHO
DOG
FUN

CROSSWORD

By Bill Ringle

(Note: You May Need An Older CLPA Directory to solve this puzzle)

(Solution on Page 44.)

1	2	3	4	5		6	7	8	9		10	11	12	13
14						15					16			
17						18					19			
				20					21	22				
23	24	25	26					27						
28						29	30							
31							32				33	34	35	
36						37	38				39			
40					41					42				
				43					44	45				
46	47	48						49	50					
51								52						
53						54	55				56	57	58	59
60						61					62			
63						64					65			

ACROSS

1. Source for ingredient of jackwax, local winter favorite.
6. Canada Lake's *Pelecypoda unionidae*.
10. Family at 372 South Shore Trail.
14. "I _____ for you," 1923 song recorded by many top singers.
15. Far East.
16. Organs of reproduction (pl.)
17. The late Emily _____ Peck, '94 CLPA prexy & Echo editor..
19. College & town in N. C., named for Hebrew word for oak.
20. French friends (pl.)
21. An old Gaelic and English woman's name.
23. "Luminous electrical atmospheric phenomena" which we see sometimes to the north.
27. Pythagoras' harmonies among the planets, the "music of the _____."
28. Ornamental hairnet seldom seen today.
29. Torpid state.
31. What radar does to the horizon, a scholar does to poetry and a computer device does to a photo.
32. Puppy's cry.
33. If you fly to Raleigh the airline puts _____ (three initials) on your luggage.
36. American trees hit by Dutch blight.
37. Cardiologist's concern.
39. Slang for thousands of dollars, or commands to a horse.
40. His (Fr. pl. adj.)
41. If it blows, your camp's in the dark.
42. Aims (n.).
43. Workers in an apple cannery.
45. What Ellen's friends call her.
46. Busy place, source of sweetness.
49. Bev _____, Echo editor emeritus
51. Barbara McMartin can _____ us with Adirondack lore.
52. Man's name popular in Prague.
53. _____ the Red, early explorer.
54. The _____, Ed and Betty, live at 236 S. Shore Road.
60. Mozart's _____ Kleine Nachtmusik
61. Tea parlors and 18th Century inns love this preface to their names.
62. A racoon on a limb, with dogs below, is _____.
63. Teacher's union (abbr., possessive)
64. Nicknames for Mr. Rohrmier of 400 Kasson Dr. and TV actor Burr
65. Once in a while you'll spot one soaring up near Arietta.

The Big Swamp

Bob and I paddled across the stream that runs by my dock, midway between the Stewarts Landing Dam and Canada Lake. Our intent was to circumnavigate (clockwise!) the big swamp about a half mile away. To get there, we needed to cross the narrow outlet of the lake.

We wanted to see a feature that looks man-made running across the width of the swamp. Unfortunately, there is no trail to get there. We'd both seen this unnatural anomaly on the satellite view in Google Maps, and wanted to know what it was.

But first, we took a short bushwhack over the hill to hit the snowmobile trail that runs parallel to the lake outlet, along the north edge of the swamp. What's a bushwhack, you ask? That's a hike with no trail. You, your compass or GPS or dead reckoning, and your legs. I advise wearing long pants, no matter what the weather.

The last time I was on this southern leg of the Stratford Snowdrifters C8 trail, it was a wreck. The 4-wheelers had turned it into muddy hole after muddier hole. It was ugly and not fun to walk on. But the DEC or someone else must have done something to let them know

they were not welcome, because the trail had mostly healed, and walking it was a pleasure. We soon came around the east end of the swamp and up the little rise that leads to a pretty little meadow. This time, the bear I saw on the previous visit was not enjoying this very peaceful place.

Years ago, my next door neighbor, Pete, told me that there was once a town in this vicinity. "Be careful you don't fall into an old well," he cautioned. I had searched several times for the remains, but even though my imagination could easily place buildings on the grassy high ground overlooking the meadow, I found little evidence of a town. "There's a huge old boiler there," he said. You can't miss it!" Maybe Pete thinks too highly of me.

Bob and I had walked out into the meadow for a better look, and then decided to make a bee line for the feature we wanted to explore. After consulting his GPS, we set out on a course that ran straight toward the mysterious feature of the internet. Bob stumbled across a couple of small gauge rails buried in the weeds. Soon after, I found a wheel mostly buried in the soil.

The Big Swamp



Our tack continued into the small gully formed by the tiny stream flowing out of the meadow. There, under the sumacs, was the boiler. Just as Pete had indicated, it was huge. It looked a lot like a locomotive without anything attached to make it motive. A locostationary? It had not moved in a long, long time.



120 years ago, nearly the entire Adirondack region was clear cut. The logging companies cut down every tree they could lay their saws on. It is likely that this boiler was used to power the saws that cut the logs into planks, since there was no appreciable waterway nearby to float the logs to a sawmill downstream. The small gauge railway was probably used to move the boiler in, and possibly also to move the sawn wood out.

Why it was left behind is a mystery. Perhaps it was no longer functional, and the value of a few tons of scrap metal was not enough to move it the miles to claim the prize. But now it's yours, if you want to drag it out...

After admiring the boiler and pondering its fate, we continued our quest, and soon managed to get a view of the feature we had seen on the computer. What a letdown. It may have been a dam at one point, but beaver engineering downstream put the whole area underwater.

Next stop was a pretty little unnamed pond south of the swamp. As we came down into its watershed, you could see the rocks and trees surrounded by water. Little white flowers dotted the marsh. I made a mental note

The Big Swamp

that late September is a great time to hike. In the summer, the deerflies and mosquitos would have carried us away. And during blackfly season? I don't want to think about it.



Three beavers put on a nice show on the far side of the little pond. A comfortable distance away, they were happy to play as we watched. Usually, when I have seen beavers, I catch a glimpse and then they're gone. These guys were happy to go about their business as we watched. We got tired of observing before they were done. There is no trail near this pond, so maybe we were so foreign to them, they didn't know that humans are bad news.

And I can only describe their business as playing. Swimming this way and that, separating and coming back together. Splashing for no apparent purpose. They treated us to a not-quite-synchronized swim.

We finished our bushwhack as we came out onto the trail that leads to the bridge over Sprite

Creek. Compared to much of the country, it's wet here in the East, even when it's dry. It had not rained in weeks, but the low spots were wet and mucky. We were glad to use the makeshift boardwalk when it was available.

Back on the trail, we expected an easy walk back to our kayaks and imminent refreshment, but another cadre of beavers supplied us with an additional obstacle. Their 50 foot wide dam was placed right atop the trail, and they had also built another downstream, so walking the trail was out of the question. The trail marker we could see on the opposite side was laughable. So rather than take a long walk to find another way, we carefully balanced ourselves and gingerly stepped across the top of the dam. The crossing was successfully dry.

Soon we arrived back and our boats and made the short paddle home. We had trekked upwards of 8 miles, and slept well that night.

Randy Fredlund

**PLEASE DRIVE
CAUTIOUSLY & SLOWLY
WHEN TRAVELING ON THE
ROADS AROUND CANADA LAKE
THIS SUMMER**

Mark and Lisa Candela would like to congratulate their son, Nicholas Candela, on his engagement to Kelley



Yablonski, daughter of Stephen and Mary Yablonski of Patchogue, New York on May 30, 2013. Their wedding will be held at the Vineyard Caterers in Aquebogue, New York on October 3, 2015.

Davis Family News: Jane and Tony stayed busy this winter skiing, playing platform tennis and spending a great deal of time enjoying the grandchildren. Everett is walking and was already on his first pair of skis! Hilary and her dad spent Sundays skiing at Stratton. Hilary still works hard at Mohawk Paper. Parker and Igoe welcomed second baby Leon on March 7th.

They are home in Sandown with their oldest Thorne. Parker stays busy with his start-up company and producing a mobile app card game for children. Tony, Hilary and Everett visited Tori, Gil, Ian and Aiden in Austin, TX. Jane and Tony escaped to the Florida Keys after the brutal winter weather.

Parker and Atni Davis returned to New England at the end of summer 2012 after a two year adventure in Montreal, Quebec where Parker served as Senior Producer on the recently released blockbuster video game Tomb Raider. Parker and Atni experienced the birth of their first child on December 5th, 2012 while wintering with Parker's family in Vermont. Thorne William Davis takes his middle name from his late great-grandfather William Arnold Petrie. The family completed their transition with a move back to their Sandown home in southern New Hampshire where they experienced the birth of their second son, Leon Rochandi Davis, on March 7, 2014. Parker continues to pursue his video game career and moonlights in game recruiting from his home office while caring for his adorable baby boys, Thorne and Leon. Atni loves her job working

for a regional high-tech staffing agency as a Technical Recruiter.

The Freeman families are eagerly looking forward to summer in “punko cove”. Jon is now established across the lake, which delights all of us. Anne’s family, who live in Pennsylvania, and Greg’s family, who live in Dallas, still treasure their time at the family camp. All expect to be there for at least a week in July and at the Labor Day festivities. We are anticipating the traditional opening flare-night party that is attended by many cousins, aunts and uncles, who all look forward to catching up with each other and fondly recalling their Canada Lake visits.

From the Family of Mabel Kane: Alex Russell, son of Bill and Barbara Russell, is a freshman at Virginia Tech in Blacksburg, Virginia. He graduated in May 2013 from the University School of Nashville where he was MVP of the Boys Varsity Golf team. The family looks forward to time at the lake in July.

The Silvernails are happy to share that our family is celebrating our 80th year on Canada Lake this summer. Glen

and Molly Silvernail purchased a small cabin under the leaning oak at 111 Hutchinson Road in 1934 so Bobby would have a place to play and they could get away from Silvernail Coal Company in Dolgeville on the weekends. In those early years, Molly would pack up her household pots and pans and bring them with her each Saturday so she could make her family their Sunday dinner at the lake. We still have pictures around camp of Glen wearing his suit vest and trousers, proudly displaying the strings of fish caught up the lake. My dad speaks so fondly of all the picnics, clambakes and visits from friends and relatives they had throughout the years. And of course of the dancing he did at Sherman’s as a young, handsome man. He met my mom at the 19th Hole and proposed to her under a full moon on the dock. The camp has gone through many changes since that first cabin but our memories are constant. My brother Rob and I spent every summer of our childhood playing in the same sand as our dad and now our children have done the same. We all cherish our time together each summer; Dad now married to Joan after my mother’s passing in 1998, Rob married to Lauren who gets

Echoes

back here each summer from California and me with Edwin, our talented craftsman and boathouse builder. Eighty years might seem like a long time, but at Canada Lake those years have flowed in a seamless continuum of 4 generations. We are so happy to be part of Canada Lake. Here's to 80 more!

Guess who turns three quarters of a century young this summer.



Happy birthday from the C.L. teenage gang circa 1954 - 2014.

Help The Town of Caroga Save Energy

Report Street Lights that are on 24 hours, or that never turn on at all by going to

www.nationalgridus.com

click on Upstate NY

Go to customer

support

click on

safety & outages

to report a Street light that needs repair, or Call the Town Clerk with the location and pole number.



Safe Boating Course

Offered on June 21st or July 12th at Caroga Town Hall from 8am to 5pm. Call 518-835-4211 ext. 21 to Register. Class size is limited. New York State law requires people between the ages of 10 and 18 to earn a safe boater's certificate in order to operate a boat alone and anyone who wishes to operate a Personal Water Craft.

Remembrances

“Michael “Mikey” J. Ackerman

(July 22, 1995 - September 22, 2013) the only child of Mike and Myrna Ackerman, grandson of Mel and Julie Ackerman, passed away tragically last Fall in an automobile accident. His family were long time residents of South Shore Trail and many will remember when his grandparents owned and operated the Nick Stoner Inn and 19th Hole. Mikey touched many hearts and lived life to the fullest. He played soccer and basketball for South Kortright High School in Delaware County, NY but his greatest love was fishing. He was an accomplished angler and enjoyed time with his friends and family fishing Canada and Lily Lake. He was a truly enjoyable young man and will be greatly missed by all those who were fortunate enough to have known him during his lifetime.”

Tom Healey

The Healey/Rohrs family lost a life-long lover of Canada Lake this past November. Thomas Healey died unexpectedly at his home in New Jersey at age 83.

Tom was born on May 31, 1930, the same month that his grandparents Henry and Nellie Rohrs completed construction of the family's summer home on Kasson Drive.

Canada Lake residents have seen Tom rowing his Adirondack pack boat up and down the length of the Lake for the past several years whenever he was here. He also swam every day, rain or shine.

Tom Healey grew up in the Bronx and graduated from Fordham University and Law School. He was a star college football player. He leaves 10 children, 3 siblings, 22 grandchildren, 2 great-grandchildren and many Healey and Rohrs cousins and relatives.

Tom loved to tell and listen to a good story and had a



Remembrances

marvelous sense of humor. He was an exceptional cook and loved to fill the camp dining room with family and friends.

Fittingly, he was the last of the clan to swim during the 2013 Canada Lake season, braving the chilly waters on October 16. He will be greatly missed. His love for the Lake lives on in his children and grandchildren.



E-MAIL ADDRESSES

The most efficient method for providing CLPA members with important, up-to-date information is through e-mail. If you have an e-mail address, and it is not correct or does not appear in the CLPA directory, go to:

*www.canadalake.mylaketown.com,
login and edit your user profile to change or add an email, or email the address to *Merryn Byrnes* merryn@juno.com.*

IN MEMORIAM

Michael Ackerman

Thomas Healey

Judson Lincoln

Bill Peck

Hubbard Smith

Word Search Answers



Crossword Key



Become a Supporting Member of the Caroga Historical Museum



A Year's Museum Membership is
\$20 single, \$25 family, \$50-99 Sponsor, \$100+ Patron

Please send a check with
name, address and phone number to
Shirley Holliday, P.O. Box 434, Caroga Lake, NY 12032

Make check payable to Caroga Historical Museum



ADOPT-A-HIGHWAY

A BIG ADOPT-A-HIGHWAY THANK YOU!

John, Chris, and Roy would like to thank the many volunteers who helped on our pickups last year. Many hardy souls cleaned trash from the roadside on several mornings during the summer. We could always use more help. If you would like to join this dandy intrepid crew, please call John Broderick (835-6150) or Chris Moritz (835-3003).



NICK STONER ISLAND

CLPA has the responsibility for maintaining the Island. Enjoy but please clean up after yourself.

- Take your garbage off the Island
- Clean up after your dog
- Make sure fires are out

The Echo Is Turning



60

Help The Celebration!

As Always the Echo is Looking for Content!

Anyone Who Submits to
The Echo 2015 60th Anniversary Edition
Will Receive a Sixty Years of Echo's CD

The CD Will Contain All The Echo's
Starting With the Original 1955 Edition

So Start Thinking How You Can Contribute

Contact Mark & Christine at echo@carogalake.com for More Info!



Fire Pumps

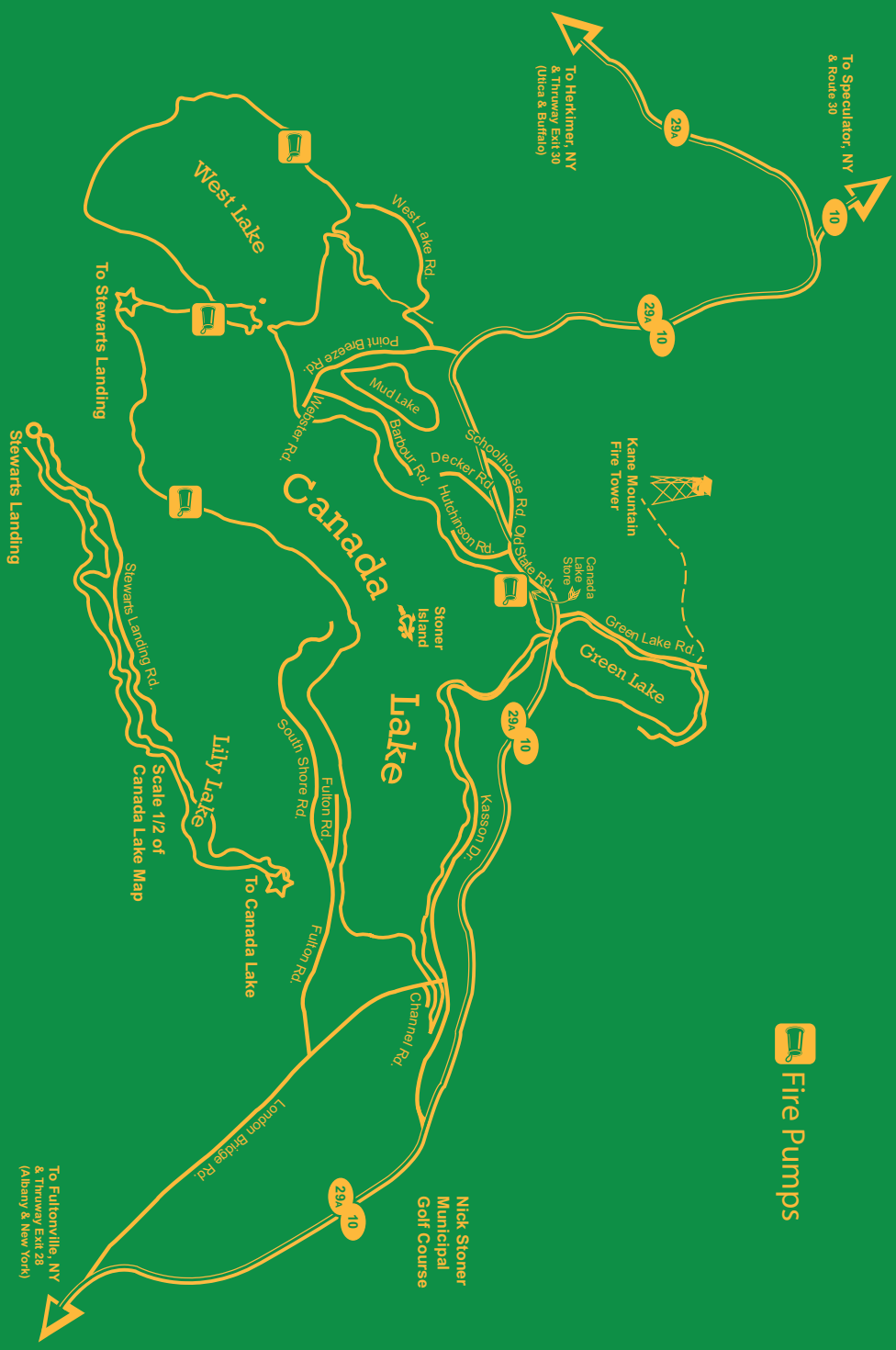

To Speculator, NY
& Route 30

To Herkimer, NY
& Thruway Exit 30
(Ulster & Buffalo)

Nick Stoner
Municipal
Golf Course

To Fultonville, NY
& Thruway Exit 28
(Albany & New York)

Scale 1/2 of
Canada Lake Map

Canada Lake